

## Flood light

### PROJ-FL08-P-200W MW

#### Picture



#### Description

Type	LED Flood light
Connection	Wire

#### Electrical Parameters

Gr. Power	200W ±5%
InputVoltage	AC100-240V
Driver	Meanwell
Dimmable	Not dim.

#### Lighting Parameters

Beam Angle	15/30/60/30*60/65*120
Colors	3000°K; 4000°K; 5000°K
Lumens	27000
CRI	80Ra

#### Structure Parameters

Fixture Color	Black; Grey
Cover	Clear
Dimensions	462*452*87mm

#### Protection Parameters

Rating	IP66/IK08/10KV SPD
Electrical Class	Class I <input checked="" type="checkbox"/> Class II <input type="checkbox"/> Class III <input type="checkbox"/>
Lifetime	>50.000h
Warranty (Years)	5

#### Options

Dimmable	Triac <input type="checkbox"/> 0-10V <input type="checkbox"/> 1-10V <input type="checkbox"/> DALI <input checked="" type="checkbox"/>
CRI	>90Ra <input type="checkbox"/> >92Ra <input type="checkbox"/> >95Ra <input type="checkbox"/> >98Ra <input type="checkbox"/>
Other	Option: Grey housing; Pole mounting bracket; Exist in economical version 120Lm/W with Sosen driver + SMD3030

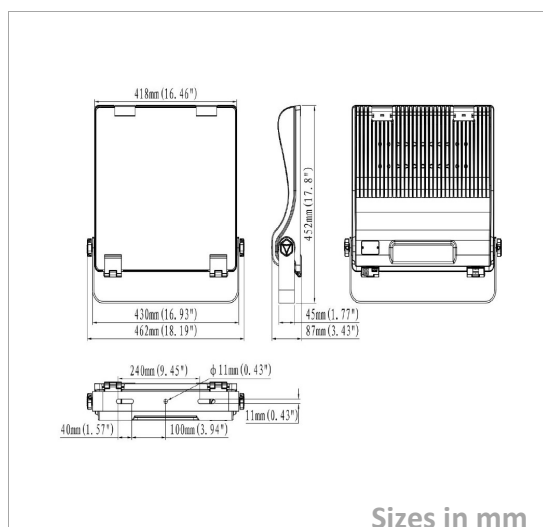

#### Packing

UnitVolum (CBM)	0,04582656
Unit GW (kg)	9,9
Qty per carton	1