

Underwater Light

POOL160R-P-COB-15W



Source	LED
Connection	Wire
Gr. Power	15W ±5%
Input Voltage	DC24V
Driver	Not Included
Control (standard)	Not dim.
Dimming option	Dimmable
Beam Angle (°)	ASY 20*40/15/25/45/60/15*45
CCT (Kelvins)	WW; DL; CW; Red; Green; Blue; Yellow
Lumens	1350
Luminaire efficiency	90 Lm/W
CRI (standard)	>80Ra
for option	
Fixture Color	SS316
Cover	Clear
Dimensions	dia 160*56(148*117)mm
Protection Rating	IP68/IK08
Electrical Class	Class III
Lifetime	>50.000h
Warranty	3 Years

Standard Packing Details

Unit Volum (CBM)	0,00469
Unit GW (kg)	2,1
Qty per carton	8

Other

In option: Mounting bracker, tripod, RGB; RGBW; DMX; available in COB

Underwater Light

POOL160R-P-COB-15W

Sizes drawing

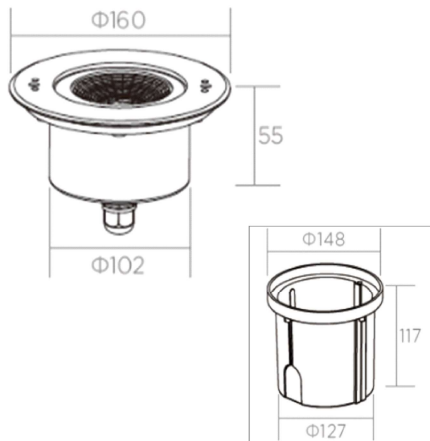

POOL160R-P-COB-15W.drw

in mm

Illumination Diagram

1350Lm with 25° beam

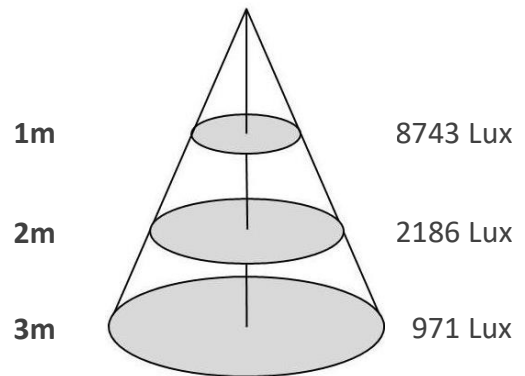

POOL160R-P-COB-15W.lux

Optic type:



Standard



COB



COB Asym

Mounting:



Recessed with sleeve



Bracket



Tripod