

JAR-SPOT-P-35W



Source	LED
Connection	Wire
Gr. Power	35W ±5%
Input Voltage	AC240V
Driver	Internal
Control (standard)	Not dim.
Dimming option	
Beam Angle (°)	15/24/38/60/15*60
CCT (Kelvins)	2700°K; 3000°K; 4000°K; 5700°K
Lumens	2880-3240
Luminaire efficiency	93 Lm/W
CRI (standard)	>80Ra
for option	
Fixture Color	Black
Cover	Clear
Dimensions	dia 115*L196*H71mm
Protection Rating	IP65/IK05
Electrical Class	Class I
Lifetime	>50.000h
Warranty	3 Years

Standard Packing Details

Unit Volum (CBM)	0,00576
Unit GW (kg)	2,5
Qty per carton	8

Other

optional: DC24V RGB; DC24V RGBW; Base; Spic; Cap; Snoot.
Does also exist in none zoomable version

JAR-SPOT-P-35W

Sizes drawing

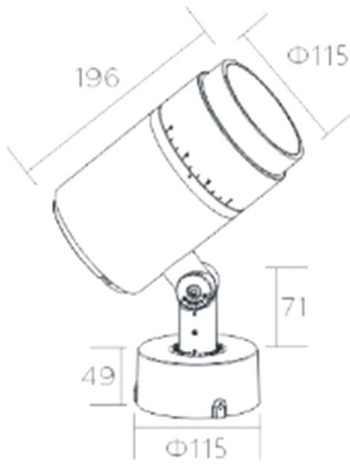

JAR-SPOT-P-35W.drw

in mm

Illumination Diagram

3240Lm with 15° beam

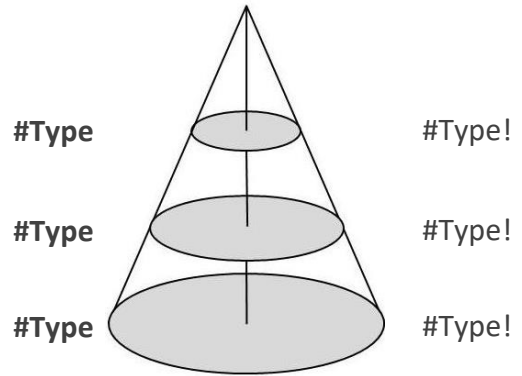

JAR-SPOT-P-35W.lux

Standard



Base



Spic



Grill



Honeycomb



Snoot



Hood



Connection Box



Connection Box with spic



Tree Strap



Pole Clamp

