

Bollard Light

BOLLARD-ML08-500-8W

Picture

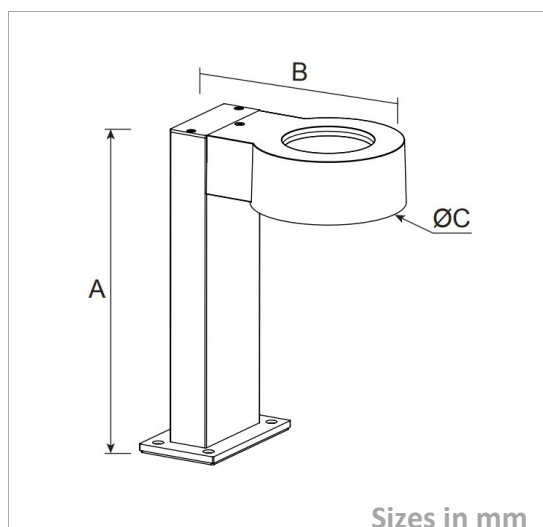

Packing

UnitVolum (CBM)	0,01837836
Unit GW (kg)	1,96
Qty per carton	6

Description

Type	LED Bollard Light
Connection	Wire

Electrical Parameters

Gr. Power	8W ±5%
InputVoltage	AC100-240V
Driver	Internal
Dimmable	Not dim.

Lighting Parameters

Beam Angle	120
Colors	3000°K; 4000°K; 5000°K; 5700°K
Lumens	600-655
CRI	80Ra

Structure Parameters

Fixture Color	Black
Cover	Frosted
Dimensions	A500*B208*C140mm

Protection Parameters

Rating	IP65/IK10
Electrical Class	Class I <input checked="" type="checkbox"/> Class II <input type="checkbox"/> Class III <input type="checkbox"/>
Lifetime	>50.000h
Warranty (Years)	3

Options

Dimmable	Triac <input type="checkbox"/> 0-10V <input type="checkbox"/> 1-10V <input type="checkbox"/> DALI <input type="checkbox"/>
CRI	>90Ra <input type="checkbox"/> >92Ra <input type="checkbox"/> >95Ra <input type="checkbox"/> >98Ra <input type="checkbox"/>
Other	